

RADIAL
1250 · 900 · 600P3S

RN
900 · 700 · 450

ESCUDRADORAS RADIALES

WOOD be nice.

OMGA



RADIAL

1250 · 900

SERIE RADIAL

Línea pesada de la gama con brazo en fundición (A). Guías de deslizamiento prismáticas aplicadas, por lo tanto fácilmente intercambiables, con desplazamiento de la unidad de corte sobre ocho cojinetes (B) provistos de guardapolvo. Bloqueadores autocentrantes tanto de la rotación del brazo como de la inclinación del motor. Barandillas de aluminio. Posibilidad de montar avance oleoneumático.

mático



A



B



RADIAL 1250 VERSION CE

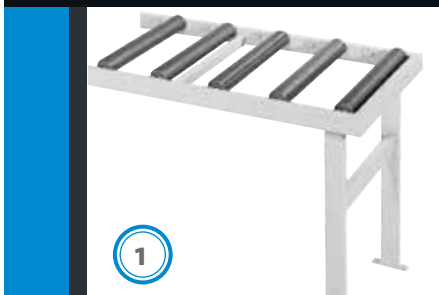

1

Bancada de rodillos (2000 / 3000 mm)



2

Protección para fresas (300x60 mm)



3

Prolongación guía
(1000 / 2000 / 3000 / 4000 mm)



4

Regreso automático



5

Prensos neumáticos

OPTIONAL



RADIAL 900

Avance oleoneumático



Prensor frontal

Elevación delantera del cabezal (R 900)

Ejes especiales (Ø 30x60)

Tope móvil (R 1250 - 900)

Tope móvil neumático (R 1250 - 900)

6



RADIAL 600P3S

SERIE RADIAL

Línea industrial de la gama con brazo de fundición. Guías de deslizamiento (A) prismáticas, fácilmente intercambiables, con desplazamiento de la unidad de corte sobre ocho cojinetes (B) provistos de guardapolvo. Bloqueadores autocentrantes tanto de la rotación del brazo como de la inclinación del motor. Barandillas de madera. Posibilidad de montar avance oleoneumático.



A



B



RADIAL 600P3S

OPTIONAL

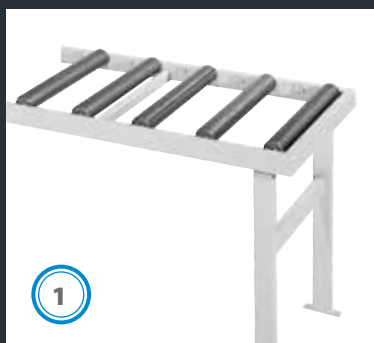

1

Bancada de rodillos (2000 / 3000 mm)



2

Protección para fresas (300x60 mm)



3

Regreso automático

Ejes especiales (Ø 30x60)



RADIAL 600P3S VERSION CE

Avance oleoneumático



Prensor frontal



RN

900 · 700 · 450

SERIE RN

Línea industrial de la gama, con brazo en aluminio. Guías de acero intercambiables de deslizamiento de la unidad de corte sobre ocho cojinetes (A) provistos de guardapolvo.

El desbloqueo del brazo se efectúa fácilmente mediante una palanca situada en la parte frontal del brazo mismo.

Bloqueadores autocentrantes tanto de la rotación del brazo (B) como de la inclinación del motor. Barandillas de madera.



RN900
VERSION CE



A



B



RN700

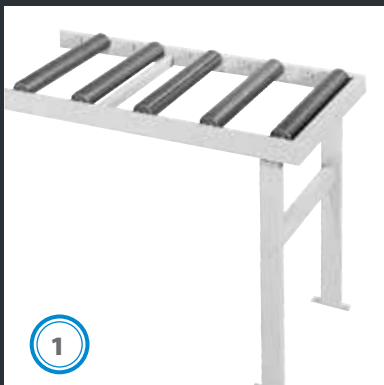

1

Bancada de rodillos (2000 / 3000 mm)



2

Protección para fresas (300x60 mm) no CE



3

Regreso automático

	RADIAL 1250	RADIAL 900	RADIAL 600P3S	RN 900	RN 700	RN 450
--	-------------	------------	---------------	--------	--------	--------

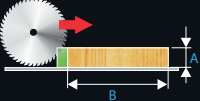
	mm A = 30 - 125 B = 1250 - 1170	A = 34 - 125 B = 900 - 825	A = 38 - 90 B = 600 - 505	A = 32 - 90 B = 900 - 825	A = 32 - 90 B = 700 - 640	A = 32 - 90 B = 450 - 390
---	---------------------------------------	-------------------------------	------------------------------	------------------------------	------------------------------	------------------------------

	mm A = 125 B = 1170	A = 125 B = 825	A = 90 B = 505	A = 90 B = 825	A = 90 B = 640	A = 90 B = 390
---	---------------------------	--------------------	-------------------	-------------------	-------------------	-------------------

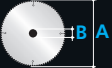
	mm A = 400 B = 30	A = 400 B = 30	A = 300 B = 30	A = 300 B = 30	A = 300 B = 30	A = 300 B = 30
	RPM 3000	3000	3000	3000	3000	3000

	kW	3,7 - 5,5	3,7 - 5,5	2,9	2,9	2,9
---	----	-----------	-----------	-----	-----	-----

	∅ mm	120	120	120	120	120
---	------	-----	-----	-----	-----	-----

	N (newton)	4165	3600	1940	2110	1780	1380
---	---------------	------	------	------	------	------	------

	LxWxH mm	2150x1520x1050	1900x1320x1100	1550x440x1080	1700x500x1280	1150x440x1100	1550x440x1100
---	-------------	----------------	----------------	---------------	---------------	---------------	---------------

H	= 1400	= 1625	= 1300	= 1545	= 1545	= 1450
L	= 1400	= 1060	= 1085	= 1085	= 900	= 840
L ¹	= 2050	= 1650	= 1485	= 1485	= 1290	= 1030
W	= 1400	= 1190	= 900	= 1215	= 900	= 800
W ¹	= 4800 CE	= 4190 CE	= 2750 CE	= 3095 CE	= 2750 CE	= 2490 CE

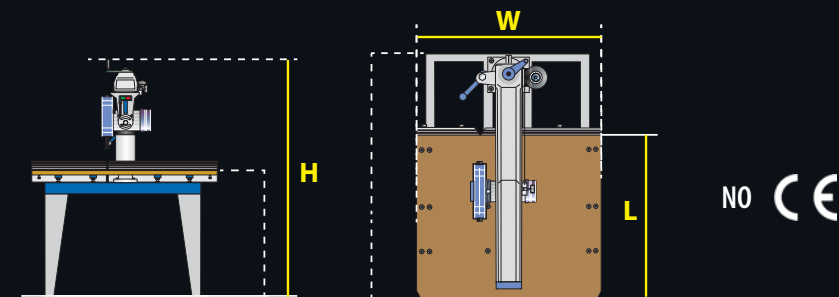
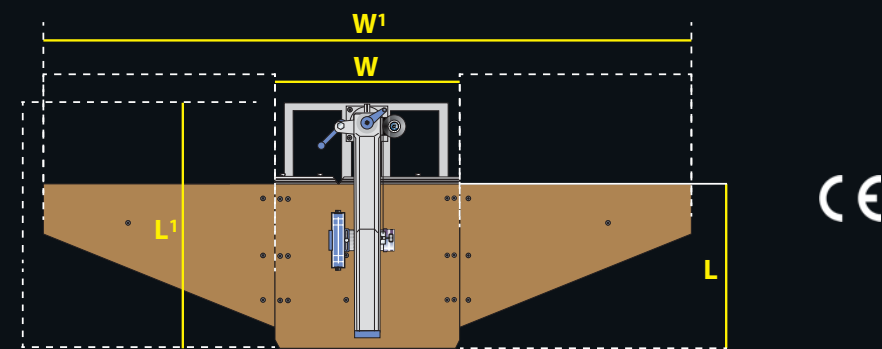
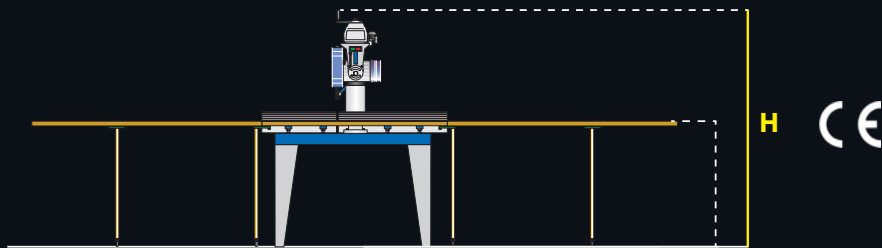

 2900204569.03

DIERREGI SRL

VIA DELLA SCIENZA 5
41012 CARPI (MO) - ITALY
PHONE: +39.059.803.0103
FAX: +39.059.803.0113
COD. FISCALE E P.IVA:
IT 03601330362

WWW.OMGA.IT

OMGA[®]
WOOD be nice.